

# INSPIRON™

## SETUP GUIDE





# INSPIRON™

## SETUP GUIDE

Model W01B

Type W01B001

# Notes, Cautions, and Warnings

 **NOTE:** A NOTE indicates important information that helps you make better use of your computer.

 **CAUTION:** A CAUTION indicates either potential damage to hardware or loss of data and tells you how to avoid the problem.

 **WARNING:** A WARNING indicates a potential for property damage, personal injury, or death.

If you purchased a Dell™ n Series computer, any references in this document to Microsoft® Windows® operating systems are not applicable.

---

**Information in this document is subject to change without notice.**

© 2009 Dell Inc. All rights reserved.

Reproduction of these materials in any manner whatsoever without the written permission of Dell Inc. is strictly forbidden.

Trademarks used in this text: *Dell*, the *DELL* logo, *YOURS IS HERE*, and *DellConnect* are trademarks of Dell Inc.; *Intel*, *Pentium*, and *Celeron* are registered trademarks and *Core* is a trademark of Intel Corporation in the U.S. and other countries; *Microsoft*, *Windows*, *Windows Vista*, and *Windows Vista* start button logo are either trademarks or registered trademarks of Microsoft Corporation in the United States and/or other countries; *Bluetooth* is a registered trademark owned by Bluetooth SIG, Inc. and is used by Dell under license.

Other trademarks and trade names may be used in this document to refer to either the entities claiming the marks and names or their products. Dell Inc. disclaims any proprietary interest in trademarks and trade names other than its own.

**June 2009**

**P/N DTN4T**

**Rev. A00**

# Contents

<b>Setting Up Your Inspiron One</b> . . . . .	<b>5</b>	Back Panel Connectors . . . . .	26
Before Setting Up Your Computer . . . . .	5	Display Features . . . . .	28
Connect the Keyboard and Mouse . . . . .	6	Software Features . . . . .	30
Connect the Power Cable . . . . .	7	Dell Dock . . . . .	34
Connect the Network Cable (Optional) . . . . .	8	<b>Solving Problems</b> . . . . .	<b>35</b>
Adjust the Computer Stand . . . . .	10	Beep Codes . . . . .	35
Press the Power Button . . . . .	11	Network Problems . . . . .	36
Set Up Microsoft Windows . . . . .	12	Power Problems . . . . .	37
Connect to the Internet (Optional) . . . . .	12	Memory Problems . . . . .	38
<b>Using Your Inspiron One</b> . . . . .	<b>16</b>	Lockups and Software Problems . . . . .	39
Right View Features . . . . .	16	<b>Using Support Tools</b> . . . . .	<b>41</b>
Right Panel Buttons and Connectors . . . . .	18	Dell Support Center . . . . .	41
Left View Features . . . . .	20	System Messages . . . . .	42
Using the Optical Drive . . . . .	22	Hardware Troubleshooter . . . . .	43
Back View Features . . . . .	24	Dell Diagnostics . . . . .	44

## Contents

<b>Restoring Your Operating System</b> .....	<b>48</b>	Returning Items for Repair Under Warranty or for Credit.....	58
System Restore .....	48	Before You Call.....	59
Dell Factory Image Restore .....	50	Contacting Dell.....	60
Operating System Reinstallation .....	52		
<b>Getting Help</b> .....	<b>54</b>	<b>Finding More Information and Resources</b> .....	<b>62</b>
Technical Support and Customer Service .....	55	<b>Basic Specifications</b> .....	<b>64</b>
DellConnect .....	55	<b>Appendix</b> .....	<b>68</b>
Online Services .....	56	Macrovision Product Notice.....	68
Automated Order-Status Service.....	57		
Product Information.....	57	<b>Index</b> .....	<b>69</b>

# Setting Up Your Inspiron One

This section provides information about setting up your Inspiron™ One.



**WARNING:** Before you begin any of the procedures in this section, read the safety information that shipped with your computer. For additional safety best practices information, see the Regulatory Compliance Homepage at [www.dell.com/regulatory\\_compliance](http://www.dell.com/regulatory_compliance).



**NOTE:** Your computer's Service Tag is located at the back of your computer. Use this code to identify your computer when you access the Dell Support website or contact technical support.

## Before Setting Up Your Computer

When positioning your computer, ensure that you allow easy access to a power source, controls and connections on the right side, adequate ventilation, and a stable level surface to place your computer.

Restricting airflow around your Inspiron One may cause it to overheat. To prevent overheating ensure that you leave at least 10.2 cm (4 inches) at the back of the computer and a minimum of 5.1 cm (2 inches) on all the other sides. You should never place your computer in an enclosed space, such as a cabinet or drawer when it is powered on.

## Connect the Keyboard and Mouse

Connect the USB keyboard and mouse to the USB connectors on the computer.

-  **NOTE:** If you purchased a wireless keyboard and mouse along with your computer, connect the USB receiver to the USB connector. For more information, see the documentation that shipped with your keyboard and mouse.

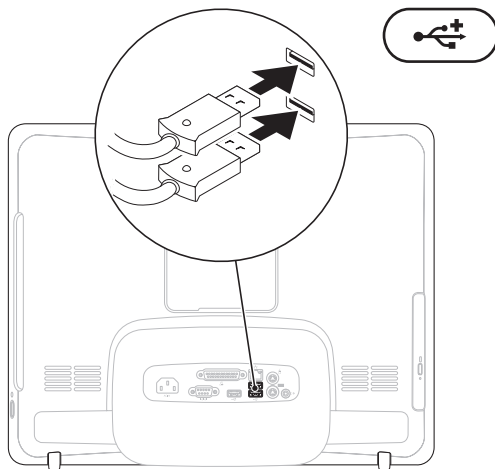



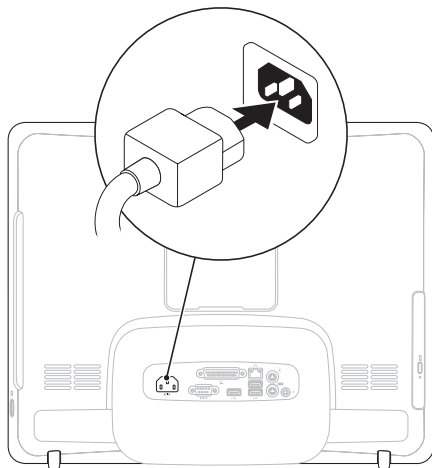

## Connect the Power Cable

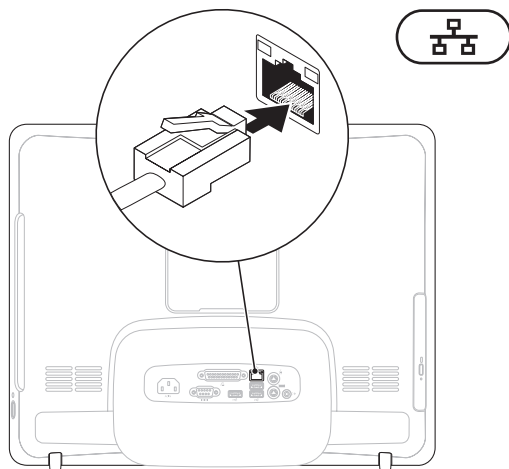

## Connect the Network Cable (Optional)



A network connection is not required to complete this computer setup, but if you have an existing network or Internet connection that uses a cable connection (such as a home cable modem or Ethernet jack), you can connect it now.

 **NOTE:** Use only an Ethernet cable (RJ45 connector) to connect to the network connector. Do not plug a telephone cable (RJ11 connector) into the network connector.

To connect your computer to a network or broadband device, connect one end of a network cable to either a network port or a broadband device. Connect the other end of the network cable to the network connector (RJ45 connector) on the back panel of your computer. A click indicates that the network cable has been securely attached.

## Adjust the Computer Stand

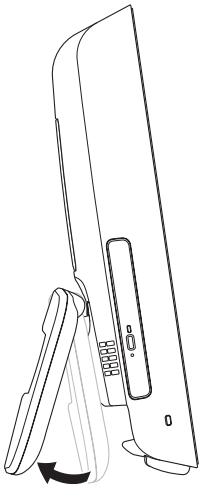

**⚠ WARNING:** Do not use the stand to carry the computer.

**✎ NOTE:** The stand must be closed before using the computer with a VESA wall mount.

Pull the stand to adjust the display to a comfortable viewing angle. A distinct click is heard when the stand is opened or closed. Your computer supports UL-certified VESA wall mounts. For proper mounting, use four (ea.) 4 mm dia, 0.7 pitch x 10.0 mm long screws.

## Press the Power Button

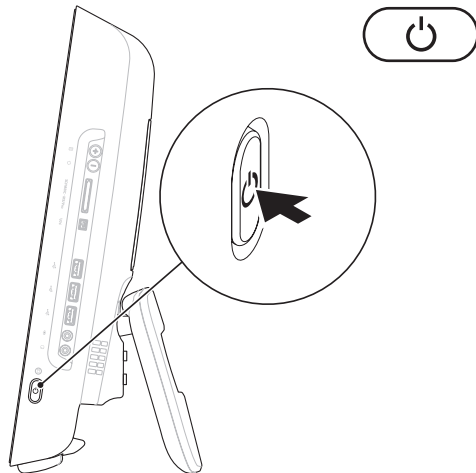

### Set Up Microsoft Windows

Your Dell computer is preconfigured with the Microsoft® Windows® operating system. To set up Windows for the first time, follow the instructions on the screen. The Windows setup screen will take you through several procedures including accepting license agreements, setting preferences, and setting up an Internet connection. The Windows setup may take some time to complete.

 **CAUTION:** Do not interrupt the operating system's setup process. Doing so may render your computer unusable and you will need to reinstall the operating system.

 **NOTE:** For optimal performance of your computer, it is recommended that you download and install the latest BIOS and drivers for your computer available on the Dell Support website at [support.dell.com](http://support.dell.com).

### Connect to the Internet (Optional)

To connect to the Internet, you need an external modem or network connection and an Internet Service Provider (ISP).

If an external USB modem or Wireless LAN adapter is not a part of your original order, you can purchase one from the Dell website at [www.dell.com](http://www.dell.com).

#### Setting Up a Wired Connection

- If you are using a dial-up connection, connect the telephone line to the external USB modem (optional) and to the telephone wall connector before you set up your Internet connection.
- If you are using a DSL or cable/satellite modem connection, contact your ISP for setup instructions.

To complete setting up your wired Internet connection, follow the instructions in “Setting Up Your Internet Connection” on page 14.

### Setting Up a Wireless Connection

Before you can use your wireless Internet connection, you need to connect to your wireless router.

#### *Windows Vista*<sup>®</sup>

1. Save and close any open files, and exit any open programs.
2. Click **Start**  → **Connect To**.
3. Follow the instructions on the screen to complete the setup.

#### *Windows*<sup>®</sup> 7

1. Save and close any open files, and exit any open programs.
2. Click **Start**  → **Control Panel** → **Network and Sharing Center** → **Connect to a network**.
3. Follow the instructions on the screen to complete the setup.

### Setting Up Your Internet Connection

ISPs and ISP offerings vary by country. Contact your ISP for offerings available in your country.

If you cannot connect to the Internet but have successfully connected in the past, the ISP might have a service outage. Contact your ISP to check the service status, or try connecting again later.

Have your ISP information ready. If you do not have an ISP, the **Connect to the Internet** wizard can help you get one.

#### *Windows Vista*

 **NOTE:** The following instructions are applicable to the Windows default view, so they may not apply if you have changed the settings on your Dell™ computer to the Windows Classic view.

1. Save and close any open files, and exit any open programs.
2. Click **Start**  → **Control Panel**.
3. Click **Network and Internet** → **Network and Sharing Center** → **Set up a connection** → **Connect to the Internet**.

The **Connect to the Internet** window appears.

 **NOTE:** If you do not know which type of connection to select, click **Help me choose** or contact your ISP.

4. Follow the instructions on the screen and use the setup information provided by your ISP to complete the setup.



*Windows 7*

1. Save and close any open files, and exit any open programs.
2. Click **Start**  → **Control Panel** → **Network and Sharing Center** → **Set up a new connection or network** → **Connect to the Internet**.

The **Connect to the Internet** window appears.

-  **NOTE:** If you do not know which type of connection to select, click **Help me choose** or contact your ISP.
3. Follow the instructions on the screen and use the setup information provided by your ISP to complete the setup.

# Using Your Inspiron One

This section provides information about the features available on your Inspiron One.

## Right View Features

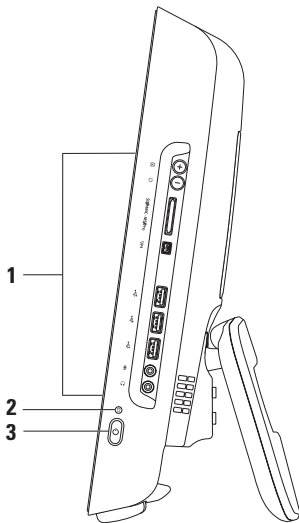

---

**1 Right panel buttons and connectors** — Adjusts brightness and connects USB, audio, and other devices into the appropriate connector.

---

**2  Hard drive activity light** — Turns on when the computer reads or writes data. A blinking light indicates hard drive activity.

 **CAUTION: To avoid loss of data, never turn off the computer, move the computer, or adjust the stand while the hard drive activity light is blinking.**

---

**3  Power button and light** — Turns the computer on or off when pressed. The light in the center of this button indicates the following power states:

- Solid amber — The system board cannot start initialization. There may be an issue with either the system board or the power supply. Contact Dell (see “Contacting Dell” on page 60).
  - Blinking amber — The computer has detected an error during the Power-on self-test (POST). Contact Dell (see “Contacting Dell” on page 60).
  - Blinking white — The computer is in sleep state.
  - Solid white — The computer is on.
  - Off — The computer is off or in hibernate state.
-

## Right Panel Buttons and Connectors

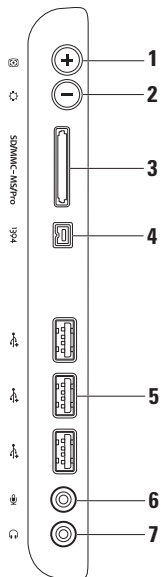

- 
-  **Auto adjust button** — Auto adjusts the display to the incoming video signal.

---

  -  **Brightness adjust button** — Provides direct access to the “Brightness” control menu. You can increase or decrease the brightness by adjusting the slider-bar control. Use the + (auto adjust button) or the - (brightness adjust button) to adjust the slider.

---

  -  **8-in-1 Media Card Reader** — Provides a fast and convenient way to view and share digital photos, music, videos, and documents stored on the following digital memory cards:
    - Secure Digital (SD) memory card
    - Secure Digital Input Output (SDIO) card
    - Multi Media Card (MMC)
    - Memory Stick
    - Memory Stick PRO
    - xD-Picture Card
    - Hi Speed-SD
    - Hi Density-SD

---

  -  **IEEE 1394a connector** — Connects to high-speed serial multimedia devices, such as digital video cameras.

---

  -  **USB 2.0 connectors (3)** — Connects to USB devices, such as a mouse, keyboard, printer, external drive, or MP3 player.

---

  -  **Microphone or line-in connector** — Connects to a microphone or an audio cable for input.

---

  -  **Headphone or line-out connector** — Connects to headphones.

**NOTE:** To connect to a powered speaker or sound system, use the line out connector on the back of your computer.

## Left View Features

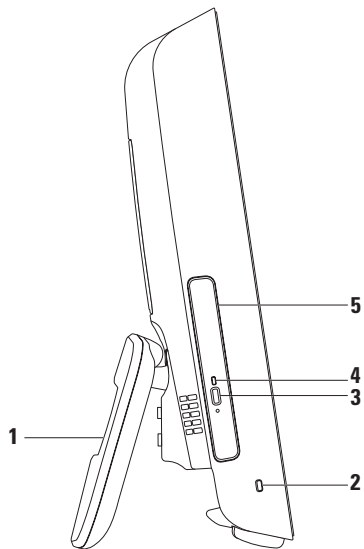

- 
- 1 Computer stand** — Provides stability to the computer and also allows you to adjust the display to a comfortable viewing angle.
- 
- 2 Security cable slot** — Attaches a commercially available lock to the computer.
- 
- 3 Optical drive eject button** — Opens the optical drive when pressed.
- 
- 4 Optical drive light** — Blinks when you press the optical drive eject button or when the disc is being read.
- 
- 5 Optical drive** — Plays or records CDs and DVDs. Ensure that you insert the disc with the printed side facing towards you.
-

## Using the Optical Drive

 **CAUTION:** Do not press down on the disc tray when you open or close it. Keep the tray closed when you are not using the drive.

 **CAUTION:** Do not move the computer while playing or recording the disc.

1. Press the eject button on the optical drive.
2. Pull out the optical drive tray.
3. Place the disc with the printed side facing towards you and snap the disc onto the spindle.
4. Gently push the optical drive tray back into the drive.



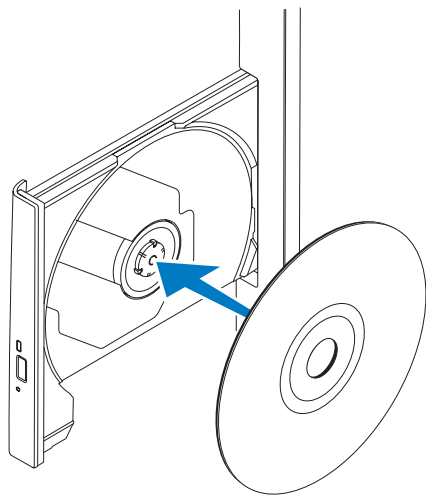

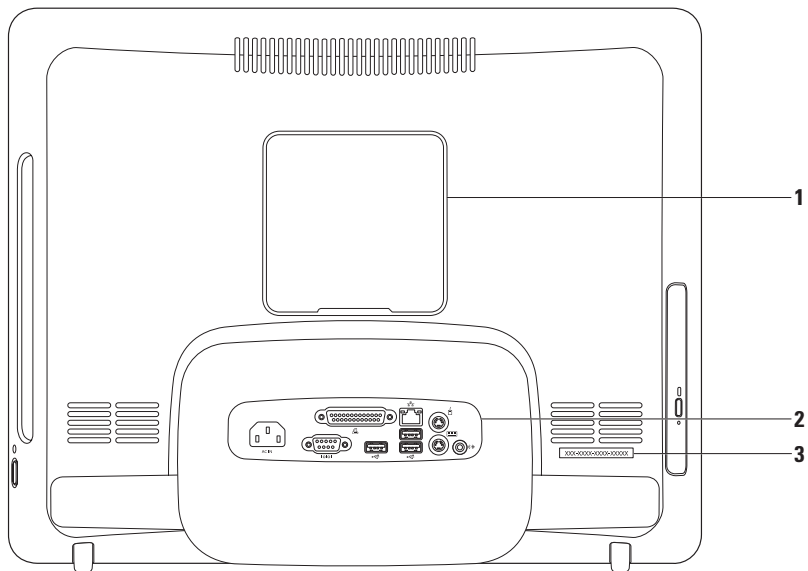

## Back View Features

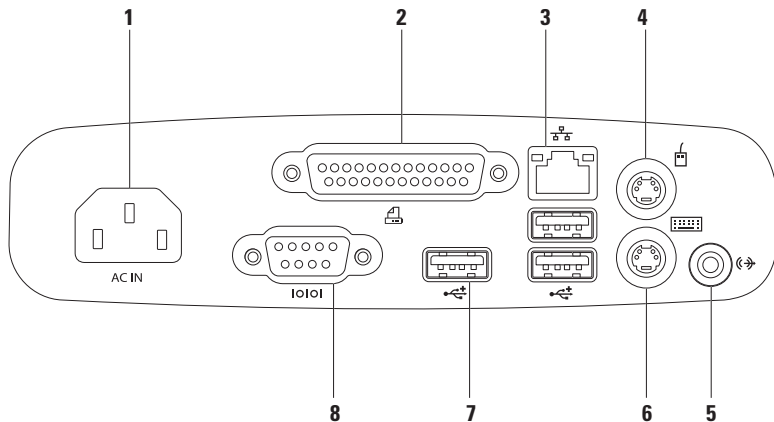

- 
- 1 VESA mount cover** — Covers the VESA mount screw holes. Remove this cover to mount your computer on a VESA mount. You can purchase the VESA mount from the Dell website at [www.dell.com](http://www.dell.com).
  - 2 Back panel connectors** — Connect USB, audio, and other devices into the appropriate connectors.
  - 3 Service Tag/Express Service Code** — Use this information to identify your computer on [support.dell.com](http://support.dell.com) or when you contact technical support.
-

## Back Panel Connectors



- 
- 1  **Power connector** — Connects to the power cable. Appearance of this connector may vary.

---

  - 2  **Parallel connector** — Connects to older printers and scanners.

---

  - 3  **Network connector** — Connects to a network or a broadband device if you are using a wired network. The two lights next to the connector indicate status and activity for wired network connection.

---

  - 4  **PS/2 Mouse connector** — Connects to a standard PS/2 mouse.

---

  - 5  **Line-out connector** — Connects to a powered speaker or sound system.

---

  - 6  **PS/2 Keyboard connector** — Connects to a standard PS/2 keyboard.

---

  - 7  **USB 2.0 connectors (3)** — Connects to USB devices, such as a mouse, keyboard, printer, external drive, or MP3 player.

---

  - 8  **Serial connector** — Connects to older printers and external modems.
-

## Display Features

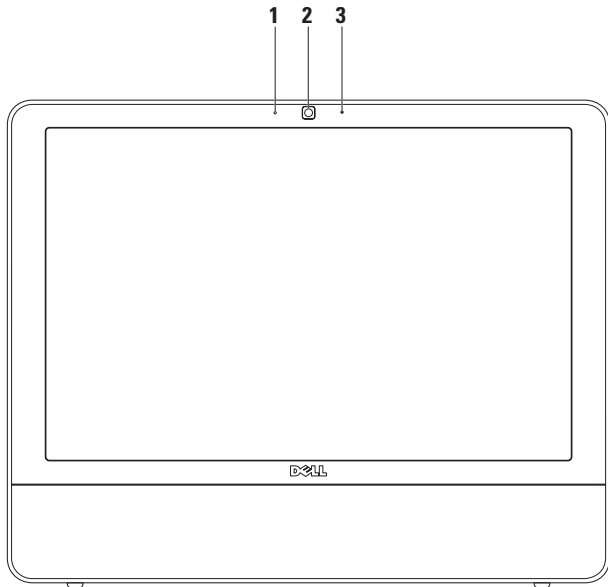

---

**1 Camera activity indicator** — Indicates if the camera is on or off.

---

**2 Camera** — Built-in camera for video capture, conferencing, and chat.

---

**3 Microphone** — Provides high quality sound for video chatting and voice recording.

---

## Software Features

 **NOTE:** For more information about the features described in this section, see the *Dell Technology Guide* available on your computer or on the Dell Support website at [support.dell.com](http://support.dell.com).

### Productivity and Communication

You can use your computer to create presentations, brochures, greeting cards, fliers, and spreadsheets. You can also edit and view digital photographs and images. Check your purchase order for software installed on your computer.

After connecting to the Internet, you can access websites, set up an e-mail account, upload and download files, and perform other related tasks.

### Entertainment and Multimedia

You can use your computer to watch videos, play games, create your own CDs, listen to music and radio stations. Your optical disc drive may support multiple disc media formats including CDs and DVDs.

You can download or copy pictures and video files from portable devices, such as digital cameras and cell phones. Optional software applications enable you to organize and create music and video files that can be recorded to disc, saved on portable products such as MP3 players and handheld entertainment devices, or played and viewed directly on connected TVs, projectors, and home theater equipment.



## Customizing the Desktop

You can use the customizing options available in your operating system to change the appearance, resolution, wallpaper, screensaver, and so on.

### *Windows Vista*

1. Right-click an open area of the desktop.
2. Click **Personalize**, to open the **Personalize appearance and sounds** window and learn more about your customization options.

### *Windows 7*

1. Right-click an open area of the desktop.
2. Click **Personalize**, to open the **Change the visuals and sounds on your computer** window and learn more about your customization options.

## Customizing Your Energy Settings

You can use the power options in your operating system to configure the power settings on your computer. Microsoft® Windows® operating system installed on your Dell computer provides the following options:

### *Windows Vista*

- **Dell Recommended** — This power option offers full performance when you need it and saves power during periods of inactivity.
- **Power saver** — This power option saves power on your computer by reducing system performance to maximize the life of the computer and by reducing the amount of energy consumed by your computer over its lifetime.

## Using Your Inspiron One

- **High performance** — This power option provides the highest level of system performance on your computer by adapting processor speed to your activity and by maximizing system performance.

### *Windows 7*

- **Power saver** — This power option saves power on your computer by reducing system performance to maximize the life of the computer and by reducing the amount of energy consumed by your computer over its lifetime.
- **Balanced (recommended)** — This power option automatically balances the performance of your computer by consuming energy only on capable hardware.

## Transferring Information to a New Computer

### *Windows Vista*

 **NOTE:** The following instructions are applicable to the Windows default view, so they may not apply if you have changed the settings on your Dell™ computer to the Windows Classic view.

1. Click **Start**  → **Control Panel** → **System and Maintenance** → **Welcome Center** → **Transfer files and settings**.  
If the **User Account Control** window appears, click **Continue**.
2. Follow the instructions on the **Windows Easy Transfer** wizard.

### Windows 7

1. Click **Start**  → **Control Panel** → **Getting Started** → **Transfer files from another computer**.
2. Follow the instructions on the **Windows Easy Transfer** wizard.

### Backing Up Your Data

It is recommended that you periodically back up files and folders on your computer. To back up files:

### Windows Vista

1. Click **Start**  → **Control Panel** → **System and Maintenance** → **Back Up and Restore Center** → **Back up files**.  
If the **User Account Control** window appears, click **Continue**.

 **NOTE:** Certain editions of Windows Vista provide an option to back up your computer.

2. Follow the instructions on the **Back Up Files** wizard.

### Windows 7

1. Click **Start**  → **Control Panel** → **Back Up and Restore**.
2. Click **Set up backup....**
3. Follow the instructions on the **Configure Backup** wizard.

# Dell Dock

The Dell Dock is a group of icons that provides easy access to frequently-used applications, files, and folders. You can personalize the Dock by:

- Adding or removing icons
- Grouping related icons into categories
- Changing the color and location of the Dock
- Changing the behavior of the icons



### Add a Category

1. Right-click the Dock, click **Add**→ **Category**. The **Add/Edit Category** window is displayed.
2. Enter a title for the category in the **Title** field.
3. Select an icon for the category from the **Select an image:** box.
4. Click **Save**.

### Add an Icon

Drag and drop the icon to the Dock or a category.

### Remove a Category or Icon

1. Right-click the category or icon on the Dock and click **Delete shortcut** or **Delete category**.
2. Follow the instructions on the screen.

### Personalize the Dock

1. Right-click the Dock and click **Advanced Setting...**
2. Choose the desired option to personalize the Dock.

# Solving Problems

This section provides troubleshooting information for your computer. If you cannot solve your problem using the following guidelines, see “Using Support Tools” on page 41 or “Contacting Dell” on page 60.

## Beep Codes

Your computer might emit a series of beeps during start-up if the monitor cannot display errors or problems. This series of beeps, called a beep code, identifies a problem.

If your computer beeps during start-up, write down the beep code and contact Dell (see “Contacting Dell” on page 60).

<b>Series of beeps (Beep code)</b>	<b>Possible Problem</b>
One	Possible motherboard failure - BIOS ROM checksum failure
Two	No RAM detected
Three	Possible motherboard failure - Chipset error
Four	RAM read/write failure
Five	Real Time Clock failure
Six	Video card or chip failure
Seven	Processor failure
Eight	Display failure

# Network Problems

## Wireless Connections

### If the wireless network connection is lost —

The wireless router is offline or wireless has been disabled on the computer.

- Check your wireless router to ensure it is powered on and connected to your data source (cable modem or network hub).
- Interference may be blocking or interrupting your wireless connection. Try moving the computer closer to your wireless router.
- Re-establish your connection to the wireless router (see “Setting Up a Wireless Connection” on page 13).

## Wired Connections

**If the wired network connection is lost** — The cable is loose or damaged.

- Check the cable to ensure it is plugged in and not damaged.

The link integrity and network activity lights on the integrated network connector lets you verify that your connection is working and provides information on the status:

### Link integrity light

- Green — A good connection exists between a 10/100-Mbps network and the computer.
- Orange — A good connection exists between a 1000-Mbps network and the computer.
- Off — The computer is not detecting a physical connection to the network.



**NOTE:** The link integrity light on the network connector is only for the wired network connection. The link integrity light does not provide status for wireless connections.

### Network activity light

- Blinking yellow — Indicates activity on the network.
- Off — Indicates no activity on the network.

## Power Problems

**If the power light is off** — The computer is in hibernate mode, turned off, or is not receiving power. There may also be a problem with the system board.

- Press the power button to resume normal operation.
- If the computer is plugged into a power strip, ensure that the power strip is plugged into an electrical outlet and that the power strip is turned on. Also bypass power protection devices, power strips, and power extension cables to verify that the computer turns on properly.
- Ensure that the electrical outlet is working by testing it with another device, such as a lamp.
- If the problem persists, contact Dell (see “Contacting Dell” on page 60).

**If the power light is solid white and the computer is not responding** —

Contact Dell (see “Contacting Dell” on page 60).

**If the power light is blinking white** —

The computer is in sleep state. Press a key on the keyboard, move the mouse, or press the power button to resume normal operation.

**If the power light is solid amber** —

The system board cannot start initialization. There may be an issue with either the system board or power supply. For assistance, contact Dell (see “Contacting Dell” on page 60).

**If the power light is blinking amber** —

The computer has detected an error during POST. The light will blink along with the three BIOS beep codes to indicate the error. For assistance, contact Dell (see “Contacting Dell” on page 60).

## Solving Problems

**If you encounter interference that hinders reception on your computer** — An unwanted signal is creating interference by interrupting or blocking other signals. Some possible causes of interference are:

- Power, keyboard, and mouse extension cables.
- Too many devices connected to a power strip.
- Multiple power strips connected to the same electrical outlet.

## Memory Problems

**If you receive an insufficient memory message** —

- Save and close any open files and exit any open programs you are not using to see if that resolves the problem.
- See the software documentation for minimum memory requirements. For assistance, contact Dell (see “Contacting Dell” on page 60).
- Run Dell Diagnostics (see “Dell Diagnostics” on page 44).

**If you experience other memory problems** —

- Run the Dell Diagnostics (see “Dell Diagnostics” on page 44).
- Contact Dell (see “Contacting Dell” on page 60).



## Lockups and Software Problems

**If the computer does not start up** — Ensure that the power cable is firmly connected to the computer and to the electrical outlet.

**If a program stops responding** —

End the program:

1. Press <Ctrl><Shift><Esc> simultaneously.
2. Click **Applications**.
3. Click the program that is no longer responding
4. Click **End Task**.

**If a program crashes repeatedly** — Check the software documentation. If necessary, uninstall and then reinstall the program.

 **NOTE:** Software usually includes installation instructions in its documentation or on the CD.

**If the computer stops responding or a solid blue screen appears** —

 **WARNING:** You might lose data if you are unable to perform an operating system shutdown.

If you are unable to get a response by pressing a key on your keyboard or moving your mouse, press the power button for at least 8 to 10 seconds until the computer turns off and then restart your computer.

**If a program is designed for an earlier Microsoft® Windows® operating system** —

Run the **Program Compatibility Wizard**. The **Program Compatibility Wizard** configures a program so that it runs in an environment similar to an earlier version of Microsoft Windows operating system environments.

## Solving Problems

### Windows Vista

1. Click **Start**  → **Control Panel** → **Programs** → **Use an older program with this version of Windows**.
2. In the welcome screen, click **Next**.
3. Follow the instructions on the screen.

### Windows 7

1. Click **Start** .
2. In the search box, type `Use an older program with this version of Windows` and press <Enter>.
3. Follow the instructions on the **Program Compatibility** wizard.

### If you have other software problems —

- Write down the error code and problem description and contact Dell (see “Contacting Dell” on page 60).
- Back up your files immediately.
- Use a virus-scanning program to check the hard drive or CDs.

- Save and close any open files or programs and shut down your computer through the **Start**  menu.
- Check the software documentation or contact the software manufacturer for troubleshooting information:
  - Ensure that the program is compatible with the operating system installed on your computer.
  - Ensure that your computer meets the minimum hardware requirements needed to run the software. See the software documentation for information.
  - Ensure that the program is installed and configured properly.
  - Verify that the device drivers do not conflict with the program.
  - If necessary, uninstall and then reinstall the program.

# Using Support Tools

## Dell Support Center

The **Dell Support Center** helps you find the service, support, and system-specific information you need.

To launch the application, click the  icon in the taskbar.

The **Dell Support Center** home page displays your computer's model number, service tag, express service code, and service contact information.

The home page also provides links to access:

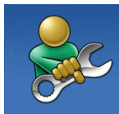

**Self Help** (Troubleshooting, Security, System Performance, Network/Internet, Backup/Recovery, and Windows operating system)



**Alerts** (technical support alerts relevant to your computer)



**Assistance from Dell** (Technical Support with DellConnect™, Customer Service, Training and Tutorials, How-To Help with Dell on Call, and Online Scan with PC CheckUp)



**About Your System** (System Documentation, Warranty Information, System Information, Upgrades & Accessories)

For more information about **Dell Support Center** and available support tools, click the **Services** tab at [support.dell.com](http://support.dell.com).

## System Messages

If your computer has an issue or error, it may display a System Message that will help you identify the cause and action needed to resolve the issue.

 **NOTE:** If the message you received is not listed in the following examples, see the documentation for either the operating system or the program that was running when the message appeared. Alternatively you could see the *Dell Technology Guide* on your hard drive or on the Dell Support website at [support.dell.com](http://support.dell.com) or see “Contacting Dell” on page 60 for assistance.

**Alert! Previous attempts at booting this system have failed at checkpoint [nnnn]. For help in resolving this problem, please note this checkpoint and contact Dell Technical Support** — The computer failed to complete the boot routine three consecutive times for the same error. Contact Dell for assistance (see “Contacting Dell” on page 60).

**CMOS checksum error** — Possible motherboard failure or RTC battery low. Contact Dell for assistance (see “Contacting Dell” on page 60).

**CPU fan failure** — CPU fan has failed. Contact Dell for assistance (see “Contacting Dell” on page 60).

**Hard-disk drive failure** — Possible hard disk drive failure during POST. Contact Dell for assistance (see “Contacting Dell” on page 60).

**Hard-disk drive read failure** — Possible hard disk drive failure during HDD boot test. Contact Dell for assistance (see “Contacting Dell” on page 60).

**Keyboard failure** — Keyboard failure or loose cable. If reseating the cable does not solve the problem, replace the keyboard.

**No boot device available** — No bootable partition on hard disk drive, the hard disk drive cable is loose, or no bootable device exists.

- If the hard drive is your boot device, ensure that the cables are connected and that the drive is installed properly and partitioned as a boot device.

- Enter system setup and ensure that the boot sequence information is correct (see the *Dell Technology Guide* on the Dell Support website at [support.dell.com](http://support.dell.com)).

**No timer tick interrupt** — A chip on the system board might be malfunctioning or motherboard failure. Contact Dell for assistance (see “Contacting Dell” on page 60).

**USB over current error** — Disconnect the USB device. Your USB device needs more power for it to function properly. Use an external power source to connect the USB device, or if your device has two USB cables, connect both of them.

**CAUTION - Hard Drive SELF MONITORING SYSTEM has reported that a parameter has exceeded its normal operating range. Dell recommends that you back up your data regularly. A parameter out of range may or may not indicate a potential hard drive problem** — S.M.A.R.T error, possible hard disk drive failure. Contact Dell for assistance (see “Contacting Dell” on page 60).

## Hardware Troubleshooter

If a device is either not detected during the operating system setup or is detected but incorrectly configured, you can use the **Hardware Troubleshooter** to resolve the incompatibility.

To start the Hardware Troubleshooter:

1. Click **Start**  → **Help and Support**.
2. Type `hardware troubleshooter` in the search field and press <Enter> to start the search.
3. In the search results, select the option that best describes the problem and follow the remaining troubleshooting steps.

### Dell Diagnostics

If you experience a problem with your computer, perform the checks in “Lockups and Software Problems” on page 39 and run the Dell Diagnostics before you contact Dell for technical assistance.

It is recommended that you print these procedures before you begin.

 **NOTE:** Dell Diagnostics works only on Dell computers.

 **NOTE:** The *Drivers and Utilities* disc is optional and may not ship with your computer.

See the *Dell Technology Guide* to review your computer’s configuration information, and ensure that the device that you want to test appears in the system setup program and is active.

Start the Dell Diagnostics from your hard drive or from the *Drivers and Utilities* disc.

### Starting Dell Diagnostics From Your Hard Drive

The Dell Diagnostics is located on a hidden diagnostic utility partition on your hard drive.

 **NOTE:** If your computer cannot display a screen image, contact Dell (see “Contacting Dell” on page 60).

1. Ensure that the computer is connected to an electrical outlet that is known to be working properly.
2. Turn on (or restart) your computer.
3. When the DELL™ logo appears, press <F12> immediately. Select **Diagnostics** from the boot menu and press <Enter>.

This will invoke the Pre-Boot System Assessment (PSA) in some computers.

 **NOTE:** If you wait too long and the operating system logo appears, continue to wait until you see the Microsoft® Windows® desktop; then, shut down your computer and try again.

 **NOTE:** If you see a message stating that no diagnostics utility partition has been found, run the Dell Diagnostics from the *Drivers and Utilities* disc.

*If PSA is invoked:*

- a. The PSA starts running tests.
- b. If the PSA completes successfully, the following message is displayed: "No problems have been found with this system so far. Do you want to run the remaining memory tests? This will take about 30 minutes or more. Do you want to continue? (Recommended)."
- c. If you are experiencing memory issues, press <y>, else press <n>.

The following message is displayed:  
"Booting Dell Diagnostic Utility Partition. Press any key to continue."

- d. Press any key to go to the **Choose An Option** window.

*If PSA is not invoked:*

Press any key to start the Dell Diagnostics from the diagnostics utility partition on your hard drive.

4. Select the test you want to run.
  5. If a problem is encountered during a test, a message appears with an error code and a description of the problem. Write down the error code and problem description and contact Dell (see "Contacting Dell" on page 60).
-  **NOTE:** The Service Tag for your computer is located at the top of each test screen. The Service Tag helps you identify your computer when you contact Dell.
6. When the tests are complete, close the test screen to return to the **Choose An Option** window.
  7. To exit the Dell Diagnostics and to restart the computer, click **Exit**.

### Starting Dell Diagnostics From the Drivers and Utilities Disc

1. Insert the *Drivers and Utilities* disc.
2. Shut down and restart the computer.  
When the DELL logo appears, press <F12> immediately.

 **NOTE:** If you wait too long and the operating system logo appears, continue to wait until you see the Microsoft® Windows® desktop; then, shut down your computer and try again.

 **NOTE:** The next steps change the boot sequence for one time only. On the next start-up, the computer boots according to the devices specified in the system setup program.

3. When the boot device list appears, highlight **CD/DVD/CD-RW** and press <Enter>.
4. Select the **Boot from CD-ROM** option from the menu that appears and press <Enter>.
5. Type 1 to start the CD menu and press <Enter> to proceed.
6. Select **Run the 32 Bit Dell Diagnostics** from the numbered list. If multiple versions are listed, select the version appropriate for your computer.
7. Select the test you want to run.



8. If a problem is encountered during a test, a message appears with an error code and a description of the problem. Write down the error code and problem description and contact Dell (see “Contacting Dell” on page 60).

 **NOTE:** The Service Tag for your computer is located at the top of each test screen. The Service Tag helps you identify your computer when you contact Dell.

9. When the tests are complete, close the test screen to return to the **Choose An Option** window.
10. To exit the Dell Diagnostics and restart the computer, click **Exit**.
11. Remove the *Drivers and Utilities* disc.

# Restoring Your Operating System

You can restore your operating system in the following ways:

- System Restore returns your computer to an earlier operating state without affecting data files. Use System Restore as the first solution for restoring your operating system and preserving data files.
- Dell Factory Image Restore returns your hard drive to the operating state it was in when you purchased the computer. This procedure permanently deletes all data on the hard drive and remove any programs installed after you received the computer. Use Dell Factory Image Restore only if System Restore did not resolve your operating system problem.
- If you received an Operating System disc with your computer, you can use it to restore your operating system. However, using the Operating System disc also deletes all data on the hard drive. Use the disc only if neither System Restore nor Dell Factory Image Restore did not resolve your operating system problem.

## System Restore

The Windows operating systems provide a System Restore option which allows you to return your computer to an earlier operating state (without affecting data files) if changes to the hardware, software, or other system settings have left the computer in an undesirable operating state. Any changes that System Restore makes to your computer are completely reversible.

 **CAUTION: Make regular backups of your data files. System Restore does not monitor your data files or recover them.**

 **NOTE:** The following instructions are applicable to the Windows default view, so they may not apply if you have changed the settings on your Dell™ computer to the Windows Classic view.

### Starting System Restore

1. Click **Start** .
2. In the search box, type `System Restore` and press <Enter>.

 **NOTE:** The **User Account Control** window may appear. If you are an administrator on the computer, click **Continue**; otherwise, contact your administrator to continue the desired action.

3. Click **Next** and remaining prompts on the screen.

In the event that System Restore did not resolve the issue, you may undo the last system restore.

### Undoing the Last System Restore

 **NOTE:** Before you undo the last system restore, save and close all open files and exit any open programs. Do not alter, open, or delete any files or programs until the system restoration is complete.

1. Click **Start** .
2. In the search box, type `System Restore` and press <Enter>.
3. Click **Undo my last restoration** and click **Next**.

# Dell Factory Image Restore

 **CAUTION:** Using Dell Factory Image Restore permanently deletes all data on the hard drive and removes any programs or drivers installed after you received your computer. If possible, back up the data before using this option. Use Dell Factory Image Restore only if System Restore did not resolve your operating system problem.

 **NOTE:** Dell Factory Image Restore is not available if the hard drive is formatted or partitioned using the Operating System disc.

 **NOTE:** Dell Factory Image Restore may not be available in certain countries or on certain computers.

Use Dell Factory Image Restore only as the last method to restore your operating system. This option restores your hard drive to the operating state it was in when you purchased the computer. Any programs or files added since you received your computer—including data files—are permanently deleted from the hard drive. Data files include documents, spreadsheets, e-mail messages, digital photos, music files, and so on. If possible, back up all data before using Factory Image Restore.

1. Turn on the computer. When the Dell logo appears, press <F8> several times to access the **Advanced Boot Options Window**.

 **NOTE:** If you wait too long and the operating system logo appears, wait until you see the Microsoft® Windows® desktop; then, shut down your computer and try again.

2. Select **Repair Your Computer**.
3. The **System Recovery Options** window appears.
4. Select a keyboard layout and click **Next**.
5. To access the recovery options, log on as a local user. To access the command prompt, type `administrator` in the **User name** field, then click **OK**.
6. Click **Dell Factory Image Restore**. The **Dell Factory Image Restore** welcome screen appears.

 **NOTE:** Depending upon your configuration, you may need to select **Dell Factory Tools**, then **Dell Factory Image Restore**.

7. Click **Next**. The **Confirm Data Deletion** screen appears.

 **NOTE:** If you do not want to proceed with Factory Image Restore, click Cancel.

8. Select the check box to confirm that you want to continue reformatting the hard drive and restoring the system software to the factory condition, then click **Next**.

The restore process begins and may take five or more minutes to complete. A message appears when the operating system and factory-installed applications have been restored to factory condition.

9. Click **Finish** to reboot the system.

# Operating System Reinstallation

### Before You Begin

If you are considering reinstalling the Microsoft® Windows® operating system to correct a problem with a newly installed driver, first try using Windows Device Driver Rollback. If Device Driver Rollback does not resolve the problem, then use System Restore to return your operating system to the operating state it was in before you installed the new device driver. See “System Restore” on page 48.

 **CAUTION:** Before performing the installation, back up all data files on your hard drive. For conventional hard drive configurations, the hard drive is the first drive detected by the computer.

Use Operating System Reinstallation disc only as the last method to restore your operating system.

To reinstall Windows, you need the following items:

- *Operating System* disc
- Dell *Drivers and Utilities* disc





**NOTE:** The Dell *Drivers and Utilities* disc contains drivers that were installed during the assembly of the computer. Use the Dell *Drivers and Utilities* disc to load any required drivers. Depending on the region from which you ordered your computer, or whether you requested the disc, the Dell *Drivers and Utilities* disc and *Operating System* disc may not ship with your computer.

## Reinstalling Microsoft Windows

The reinstallation process can take 1 to 2 hours to complete. After you reinstall the operating system, you must also reinstall the device drivers, virus protection program, and other software.

1. Save and close any open files and exit any open programs.
2. Insert the *Operating System* disc.
3. Click **Exit** if the **Install Windows** message appears.
4. Restart the computer.
5. When the DELL logo appears, press <F12> immediately.

 **NOTE:** If you wait too long and the operating system logo appears, wait until you see the Microsoft® Windows® desktop; then, shut down your computer and try again.

 **NOTE:** The next steps change the boot sequence for one time only. On the next start-up, the computer boots according to the devices specified in the system setup program.

6. When the boot device list appears, highlight **CD/DVD/CD-RW Drive** and press <Enter>.
7. Press any key to **Boot from CD-ROM**. Follow the instructions on the screen to complete the installation.

# Getting Help

If you experience a problem with your computer, you can complete the following steps to diagnose and troubleshoot the problem:

1. See “Solving Problems” on page 35 for information and procedures that pertain to the problem your computer is experiencing.
2. See the *Dell Technology Guide* for more troubleshooting information.
3. See “Dell Diagnostics” on page 44 for procedures on how to run Dell Diagnostics.
4. Fill out the “Diagnostic Checklist” on page 60.
5. Use Dell’s extensive suite of online services available at Dell Support ([support.dell.com](http://support.dell.com)) for help with installation and troubleshooting procedures. See “Online Services” on page 56 for a more extensive list of Dell Support online.
6. If the preceding steps have not resolved the problem, see “Before You Call” on page 59.



**NOTE:** Call Dell Support from a telephone near or at the computer so that the support staff can assist you with any necessary procedures.



**NOTE:** Dell’s Express Service Code system may not be available in all countries.



When prompted by Dell's automated telephone system, enter your Express Service Code to route the call directly to the proper support personnel. If you do not have an Express Service Code, open the **Dell Accessories** folder, double-click the **Express Service Code** icon, and follow the directions.

 **NOTE:** Some of the services are not always available in all locations outside the continental U.S. Call your local Dell representative for information on availability.

## Technical Support and Customer Service

Dell's support service is available to answer your questions about Dell hardware. Our support staff use computer-based diagnostics to provide fast, accurate answers.

To contact Dell's support service, see "Before You Call" on page 59 and then see the contact information for your region or go to **support.dell.com**.

## DellConnect

DellConnect™ is a simple online access tool that allows a Dell service and support associate to access your computer through a broadband connection, diagnose your problem and repair it all under your supervision. For more information, go to **www.dell.com/DellConnect**.

### Online Services

You can learn about Dell products and services on the following websites:

- **www.dell.com**
- **www.dell.com/ap** (Asian/Pacific countries only)
- **www.dell.com/jp** (Japan only)
- **www.euro.dell.com** (Europe only)
- **www.dell.com/la** (Latin American and Caribbean countries)
- **www.dell.ca** (Canada only)

You can access Dell Support through the following websites and e-mail addresses:

#### Dell Support websites

- **support.dell.com**
- **support.jp.dell.com** (Japan only)
- **support.euro.dell.com** (Europe only)
- **supportapj.dell.com** (Asia Pacific only)

#### Dell Support e-mail addresses

- **mobile\_support@us.dell.com**
- **support@us.dell.com**
- **la-techsupport@dell.com** (Latin America and Caribbean countries only)
- **apsupport@dell.com** (Asian/Pacific countries only)

#### Dell Marketing and Sales e-mail addresses

- **apmarketing@dell.com** (Asian/Pacific countries only)
- **sales\_canada@dell.com** (Canada only)

#### Anonymous file transfer protocol (FTP)

- **ftp.dell.com**  
Log in as user: `anonymous`, and use your e-mail address as your password.

## Automated Order-Status Service

To check on the status of any Dell products that you have ordered, you can go to **support.dell.com**, or you can call the automated order-status service. A recording prompts you for the information needed to locate and report on your order. For the telephone number to call your region, see “Contacting Dell” on page 60.

If you have a problem with your order, such as missing parts, wrong parts, or incorrect billing, contact Dell for customer assistance. Have your invoice or packing slip handy when you call. For the telephone number to call for your region, see “Contacting Dell” on page 60.

## Product Information

If you need information about additional products available from Dell, or if you would like to place an order, visit the Dell website at **www.dell.com**. For the telephone number to call for your region or to speak to a sales specialist, see “Contacting Dell” on page 60.

## Returning Items for Repair Under Warranty or for Credit

Prepare all items being returned, whether for repair or credit, as follows:

 **NOTE:** Before you return the product to Dell, make sure to back up any data on the hard drive and on any other storage device in the product. Remove any and all confidential, proprietary and personal information, as well as removable media, such as CDs and PC Cards. Dell is not responsible for any of your confidential, proprietary or personal information; lost or corrupted data; or damaged or lost removable media that may be included with your return.

1. Call Dell to obtain a Return Material Authorization Number, and write it clearly and prominently on the outside of the box.  
 **NOTE:** For the telephone number to call for your region, see “Contacting Dell” on page 60.
2. Include a copy of the invoice and a letter describing the reason for the return.
3. Include a copy of the Diagnostics Checklist (see “Diagnostic Checklist” on page 60), indicating the tests that you have run and any error messages reported by the Dell Diagnostics (see “Dell Diagnostics” on page 44).
4. Include any accessories that belong with the item(s) being returned (power cables, software, guides, and so on) if the return is for credit.

5. Pack the equipment to be returned in the original (or equivalent) packing materials.

 **NOTE:** You are responsible for paying shipping expenses. You are also responsible for insuring any product returned, and you assume the risk of loss during shipment to Dell. Collect On Delivery (C.O.D.) packages are not accepted.

 **NOTE:** Returns that are missing any of the preceding requirements will be refused at Dell's receiving dock and returned to you.

## Before You Call

 **NOTE:** Have your Express Service Code ready when you call. The code helps Dell's automated-support telephone system direct your call more efficiently. You may also be asked for your Service Tag (located on the back of your computer).

Remember to fill out the following Diagnostic Checklist. If possible, turn on your computer before you call Dell for assistance and call from a telephone at or near the computer. You may be asked to type some commands at the keyboard, relay detailed information during operations, or try other troubleshooting steps possible only at the computer itself. Ensure that the computer documentation is available.

### Diagnostic Checklist

- Name:
- Date:
- Address:
- Phone number:
- Service Tag (bar code on the back of the computer):
- Express Service Code:
- Return Material Authorization Number (if provided by Dell support technician):
- Operating system and version:
- Devices:
- Expansion cards:
- Are you connected to a network? Yes/No
- Network, version, and network adapter:
- Programs and versions:

See your operating system documentation to determine the contents of the computer's start-up files. If the computer is connected to a printer, print each file. Otherwise, record the contents of each file before calling Dell.

- Error message, beep code, or diagnostic code:
- Description of problem and troubleshooting procedures you performed:

### Contacting Dell

For customers in the United States, call 800-WWW-DELL (800-999-3355).



**NOTE:** If you do not have an active Internet connection, you can find contact information on your purchase invoice, packing slip, bill, or Dell product catalog.

Dell provides several online and telephone-based support and service options. Availability varies by country and product, and some services may not be available in your area.

To contact Dell for sales, technical support, or customer service issues:

1. Visit **support.dell.com**.
2. Verify your country or region in the **Choose A Country/Region** drop-down menu at the bottom of the page.
3. Click **Contact Us** on the left side of the page.
4. Select the appropriate service or support link based on your need.
5. Choose the method of contacting Dell that is convenient for you.

# Finding More Information and Resources

## If you need to:

---

reinstall your operating system

---

run a diagnostic program for your computer, reinstall desktop system software, or update drivers for your computer, and readme files

---

learn more about your operating system, maintaining peripherals, RAID, Internet, Bluetooth®, networking, and e-mail

---

find safety best practices information for your computer

---

review Warranty information, Terms and Conditions (U.S. only), Safety instructions, Regulatory information, Ergonomics information, and End User License Agreement

---

## See:

---

the Operating System disc

---

the *Drivers and Utilities* disc



**NOTE:** Drivers and documentation updates can be found on the Dell™ Support website at [support.dell.com](http://support.dell.com).

---

the *Dell Technology Guide* installed on your hard drive

---

the safety and regulatory documents that shipped with your computer and also see the Regulatory Compliance Homepage at [www.dell.com/regulatory\\_compliance](http://www.dell.com/regulatory_compliance)

---



**If you need to:**

**See:**

---

find your Service tag/Express Service Code — You must use the service tag to identify your computer on **support.dell.com** or to contact technical support

the back of your computer

---

find drivers and downloads  
access technical support and product help  
check on your order status for new purchases  
find solutions and answers to common questions  
locate information for last-minute updates about technical changes to your computer or advanced technical-reference material for technicians or experienced users

---

the Dell™ Support website at **support.dell.com**

# Basic Specifications

## System Model

---

Inspiron One 19

This section provides information that you may need when setting up, updating drivers for, and upgrading your computer. For more detailed specifications, see the *Service Manual* on the Dell Support website at [support.dell.com](http://support.dell.com).



**NOTE:** Offerings may vary by region.

For more information regarding the configuration of your computer, click **Start** → **Help and Support** and select the option to view information about your computer.

## Processor

---

Intel® Celeron®

Intel Celeron Dual-Core

Intel Pentium® Dual-Core

Intel Core™2 Duo

Intel Core2 Quad

## Drives and Devices

---

Drives	One 3.5-inch internal hard-drive, one tray-load optical drive
Wireless (optional)	LAN 802.11 b/g
Camera	1.3 mega pixel

**Drives and Devices**

Available devices	Serial ATA hard drive, DVD-ROM (optional), DVD+/- RW (optional), microphone array, and 8-in-1 Media Card Reader
-------------------	---

**Memory**

Type	Dual channel 800 MHz DDR2
Minimum	1 GB
Maximum	4 GB

**Computer Information**

System chipset	Intel G41+ICH7
----------------	----------------

**External Connectors**

Network adapter	RJ45 connector
USB 2.0	Three side-panel and three back-panel connectors
Audio	Two side-panel connectors for microphone/line-in and headphone/line-out; one back-panel connector for line-out
IEEE 1394a	one side-panel 4-pin serial connector

## Basic Specifications

<b>Video</b>	
Type	Intel X4500
<b>Audio</b>	
Type	Integrated speakers
<b>Display</b>	
Type (active-matrix TFT)	18.5 inches, 16:9, WXGA
Maximum resolution	1366 x 768
<b>Power</b>	
Wattage	130 W
Voltage	100-240 VAC
Backup battery	3-V CR2032 lithium coin cell

<b>Physical</b>	
Height	386.39 mm (15.21 inches)
Width	477.39 mm (18.79 inches)
Depth	103.98 mm (4.09 inches)
Weight (approximate)	7.3 kg (16.1 lb)
<b>Computer Environment</b>	
<i>Temperature:</i>	
Operating	10°C to 35°C (50°F to 95°F)
Storage	-40°C to 65°C (-40°F to 149°F)
Relative humidity	10% to 90% (non-condensing)

**Computer Environment***Maximum vibration:*

Operating	0.26 GRMS random for 2 min in all operational orientations
Storage	2.2 GRMS random for 15 mins

*Maximum shock:*

Operating	Half-Sine Pulse: 40G for 2ms with a change in velocity of 20 in/s (51 cm/s)
Storage	Half-Sine Pulse: 40G for 22 ms with a change in velocity of 240 in/s (609 cm/s)

**Computer Environment***Altitude:*

Operating	-15.2 to 3048 m (-50 to 10,000 ft)
Storage	-15.2 to 10,668 m (-50 to 35,000 ft)
Airborne containment level	G2 or lower as defined by ISA-S71.04-1985

# Appendix

## Macrovision Product Notice

This product incorporates copyright protection technology that is protected by method claims of certain U.S. patents and other intellectual property rights owned by Macrovision Corporation and other rights owners. Use of this copyright protection technology must be authorized by Macrovision Corporation, and is intended for home and other limited viewing uses only unless otherwise authorized by Macrovision Corporation. Reverse engineering or disassembly is prohibited.

# Index

## A

- airflow, allowing **5**
- audio **66**

## B

- backups
  - creating **33**

## C

- calling Dell **59**
- CDs, playing and creating **30**
- chipset **65**
- computer
  - weights and dimensions **66**
- computer capabilities **30**
- computer environment **66**

- computer information **65**
- computer, setting up **5**
- connect(ing)
  - optional network cable **8**
- conserving energy **31**
- Contacting Dell online **60**
- customer service **55**
- customizing
  - your desktop **30**
  - your energy settings **31**

## D

- data, backing up **32**
- DellConnect **55**
- Dell Diagnostics **44**
- Dell Factory Image Restore **48**

## Index

- Dell Support Center **41**
- Dell support website **63**
- Dell Technology Guide
  - for further information **62**
- Diagnostic Checklist **59**
- disc drive
  - supported disc sizes **22**
- discs
  - using **22**
- drivers and downloads **63**
- drives and devices **64**
- DVDs, playing and creating **30**

## E

- email addresses
  - for technical support **56**

- energy
  - conserving **31**
- expansion bus **66**

## F

- finding more information **62**
- front-side connectors **16**
- FTP login, anonymous **56**

## H

- hard drive activity light **17**
- hardware problems
  - diagnosing **43**
- Hardware Troubleshooter **43**
- headphone
  - front connector **19**
- help
  - getting assistance and support **54**



**I**

Internet connection **12**

ISP

Internet Service Provider **12**

**L**

line-in connector **19**

**M**

media card reader **19**

memory

minimum and maximum **65**

memory problems

solving **38**

Memory Stick reader **19**

memory support **65**

microphone connector **19**

MMC **19**

Multi Media Card reader **19**

**N**

network connection

fixing **36**

network speed

testing **36**

**P**

physical specifications **66**

ports and connectors **65**

power button and light **17**

power problems, solving **37**

power specifications **66**

problems, solving **35**

processor **64**

products

information and purchasing **57**

### R

- reinstalling Windows **48**
- resources, finding more **62**
- restoring factory image **50**

### S

- setup, before you begin **5**
- shipping products
  - for return or repair **58**
- software features **30**
- software problems **39**
- solving problems **35**
- specifications **64**
- support email addresses **56**
- support sites
  - worldwide **55**
- System Messages **42**
- System Restore **48**

### U

- USB 2.0
  - back connectors **27**

### V

- ventilation, ensuring **5**

### W

- warranty returns **58**
- Windows, reinstalling **48**
- Windows Vista® **12**
  - Program Compatibility Wizard **39**
  - reinstalling **53**
- wireless network connection **36**

### X

- xD-Picture Card reader **19**





Printed in the U.S.A.

[www.dell.com](http://www.dell.com) | [support.dell.com](http://support.dell.com)



ODTN4TA00